

XLFE-MIA



- Zone 1, 2, 21, 22
- Obstruction warnings MEDIUM INTENSITY type A or C
- LED technology
- Lifespan more than 10 years
- Easy to install
- Complies with ICAO, FAA

'Ex op is'
safe optical radiation



Ex e terminal box for fast connection



XLFE-MIA Medium intensity LED Obstruction lighting fixtures

XLFE-MIA and XLFE-MIC series medium intensity LED Obstruction lighting fixtures can be installed in hazardous areas of industrial plants classified as Zone 1, Zone 2, Zone 21, Zone 22.

The flashing white color XLFE-MIA, with an intensity greater than 20,000 candles in daytime operation and greater than 2,000 candles in night-time operation, complies with ICAO annex 14 for aviation obstruction warning lights of medium-intensity type A (corresponding to the FAA type of initials L-865).

The fixed RED color XLFE-MIC, with an intensity greater than 2,000 candles, complies with ICAO annex 14 for aviation obstruction warning lights of medium-intensity type C (corresponding to the FAA type of initials L-864).

The XLFE-MIA and XLFE-MIC series have been designed for Zone 1 with an 'Ex db' optical source. The particular design avoids any type of optical error typical of the glass globes. The lamp body performs both the function of explosion protection and heat sink, thus avoiding the use of resin-coated optics, which are subject to deterioration over time.

The signalling device is not a stand-alone device but it is part of a system that provides power from a control panel. This choice reduces maintenance operations by making the power supplies accessible from the control panel.

With this system it is possible to manage the control of the lighting equipment failures, the eventual switching on of the spare indicators, the synchronization between different control panels also via cable or GPS technology.

Application sectors:



CERTIFICATION DATA

Classification:	Group II	Category 2GD		
Installation:: EN 60079.14	zone 1 - zone 2 (Gas)	zone 21 - zone 22 (Dust)		
Marking:	CE 0722 Ex II 2GD Ex db eb IIC T.. °C Gb; Ex tb IIC T.. °C Db IP66			
Certification:	ATEX CML 19 ATEX 1333X			
	IECEx IECEx CML 19.0102X	For all IEC Ex and UKEX certificate data download the certificate from www.cortemgroup.com		
	UKEX AVAILABLE			
Standards:	CENELEC EN 60079-0: 2018, EN 60079-1: 2014, EN 60079-31: 2014, EN 60079-28: 2015, EN 60079-7: 2015 and DIRETTIVA EUROPEA 2014/34/UE IEC 60079-0: 2017, IEC 60079-1: 2014-06, IEC 60079-28: 2015, IEC 60079-31: 2013, IEC 60079-7: 2017 European Directive 2004/108 Electromagnetic compatibility European Directive 2012/19/UE, 2002/96/CE, 2003/108/CE WEEE European Directive 2011/65/UE RoHS			
Class temperature:	70°C (T6)	90°C (T5)		
Ambient temperature:	-40°C +40°C (T6)	-40°C +60°C (T5)		
Degree of protection:	IP66			

XLFE-MIA Medium intensity LED Obstruction lighting fixtures



ORIGINAL PRODUCT

MECHANICAL FEATURES

Body:	Low copper content aluminium alloy fitted with cooling fins for better heat dissipation
Finish:	Anodic oxidation surface treatment suitable for structural parts with high corrosion resistance requirements.
Glass face:	Shock and temperature resistant borosilicate glass sealed with aluminium shade ring
Internal reflector:	Chrome-plated aluminum
Gaskets:	Silicone acid/hydrocarbon and high temperatures resistant
Mounting:	See "XLFE-MIA series dimensional drawings"
Bolts and screws:	Stainless steel
Entries:	1 ISO M20 entry

ACCESSORIES AVAILABLE / SPECIAL REQUESTS

The fixed RED color **XLFE-MIC**, with an intensity greater than 2,000 candles, complies with ICAO annex 14 for aviation obstruction warning lights of medium-intensity type C (corresponding to the FAA type of initials L-864).

Ex or watertight protected control panel

Cable gland: NAV20IB for non-armoured cable or NEV20IB for armoured cable

Heat shield

Polyester painting

COMPLIANCE

ICAO Regulations, FAA. The white XLFE-MIA series lighting fixtures, with an intensity greater than 20,000 candles in daytime operation and greater than 2,000 candles in nighttime operation, complies with ICAO annex 14 vol I. June 2016 for aviation obstruction warning lights of medium-intensity type A (corresponding to the FAA type of initials L-865). In accordance with the provisions of this standard, the luminous flux of the lighting fixture on the horizontal plane is 360° while on the vertical plane it is 3°.



Patent Pending



XLFE-MIA Medium intensity LED Obstruction lighting fixtures

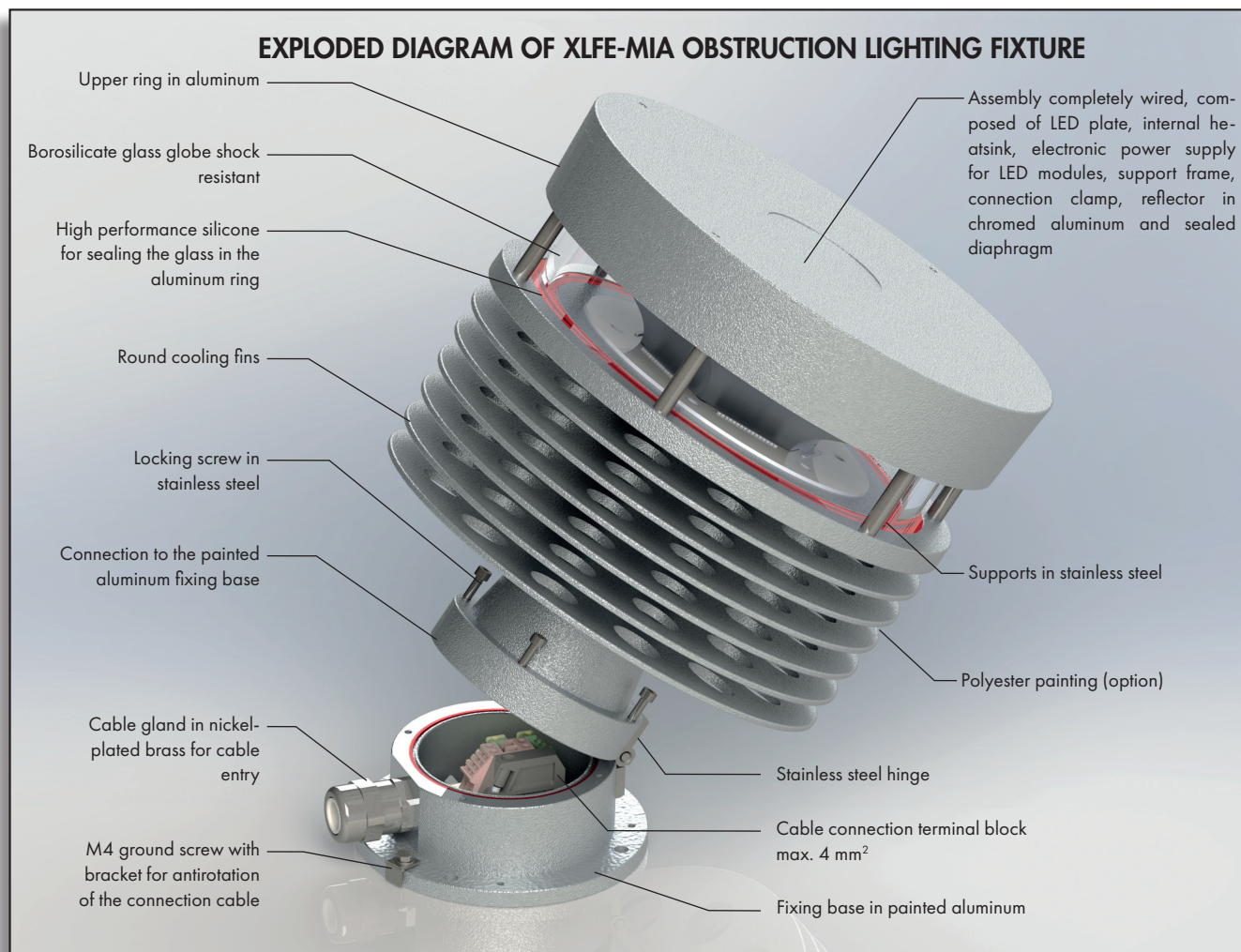

Features	XLFE-MIA
Type of product:	Obstruction lighting fixture Average intensity Type A
Light source:	LED
Color:	White
Typical use:	Day and night hours
Power consumption:	60 W
Connection:	Direct connection to terminal board L, N, Pe. Section 4mm ²
Flashing rate:	20 - 40 fpm (flash for minute)
Vertical beam spread:	3°
Minimum light intensity (360°):	20.000 cd daytime operation 2.000 cd in nighttime
Horizontal coverage:	360°

XLFE-MIA Medium intensity LED Obstruction lighting fixtures

Code	Colour light	Type of light	Type of circuit	Power	Weight kg	 mm
XLFE-MIA	White	Flash	Single	60 W	8,5	260x250x300

DIMENSIONAL DRAWING

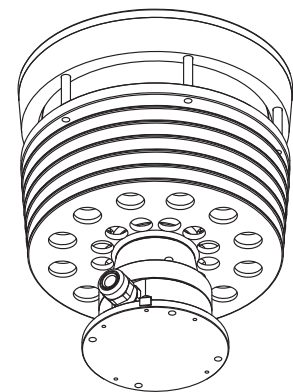
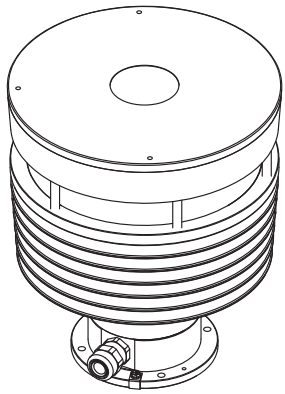

Close up of mounting

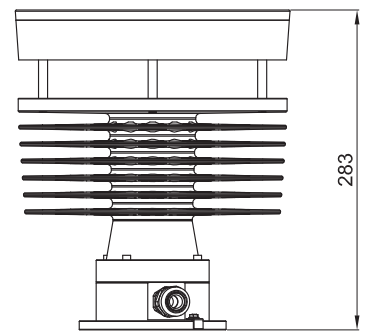
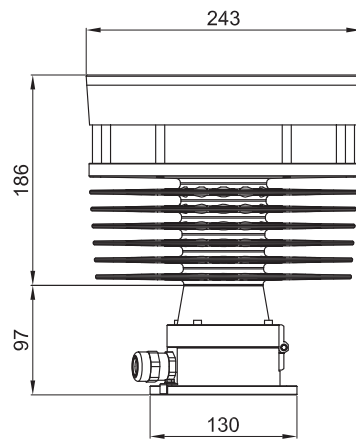
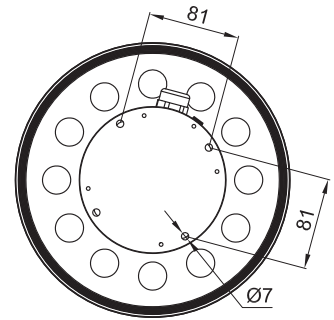

Dimensions in mm

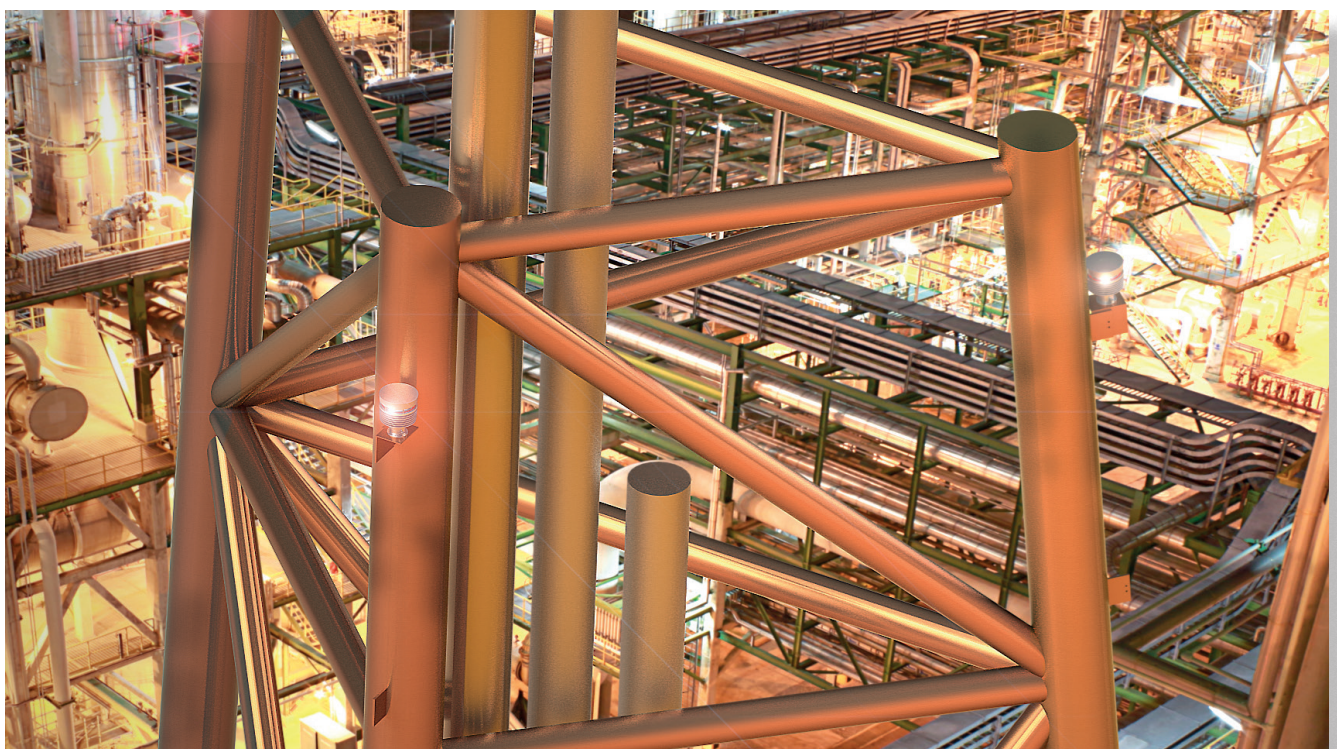

XLFE-MIA Medium intensity LED Obstruction lighting fixtures

Products selection flow-chart

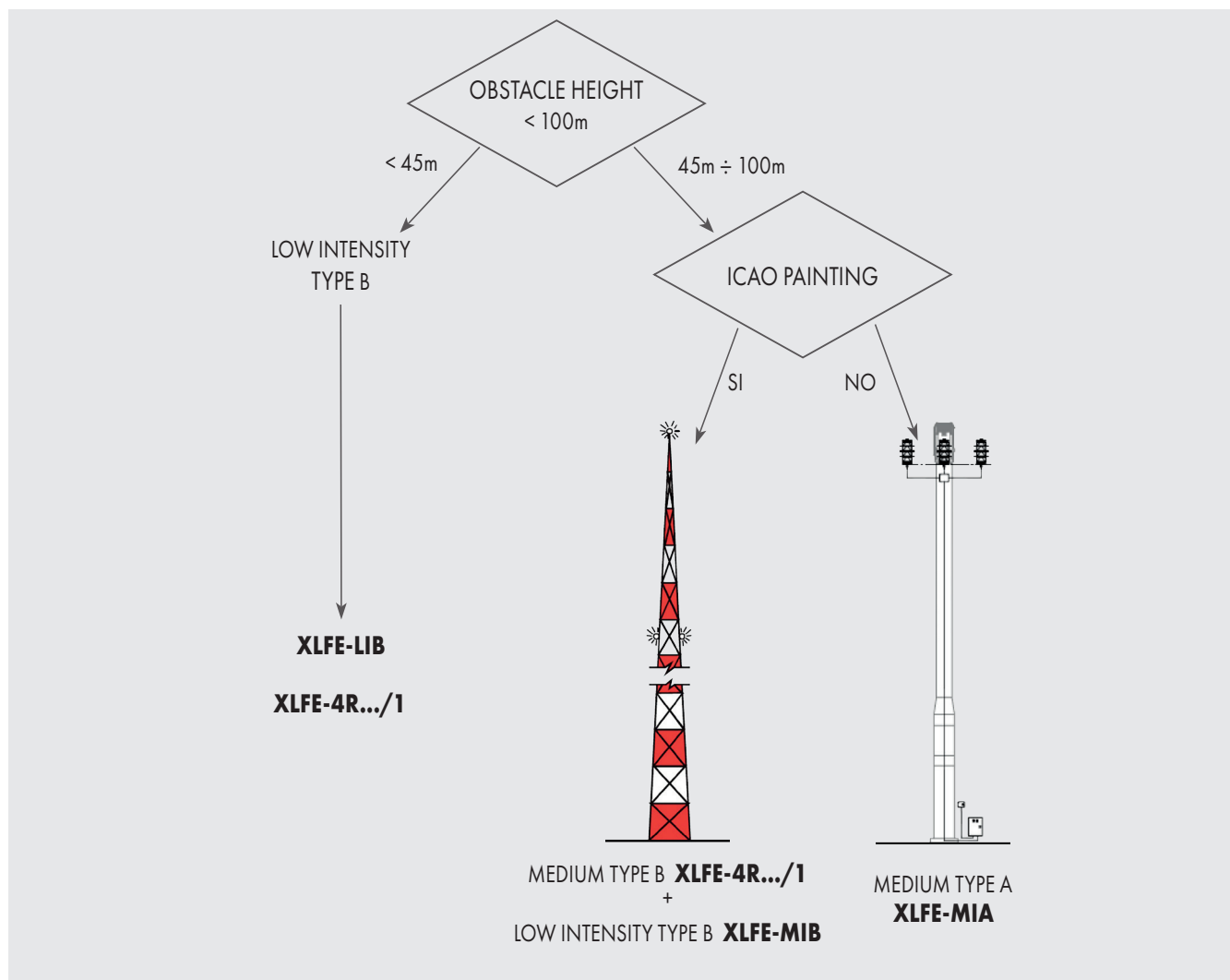

Mounting scheme

